



Aplus, Reliable Power Brand Deserve Your Trust



USER'S MANUAL

Uninterruptible Power Supply

Uninterruptible Power System

LV system: 100/110/120/125Vac

HV system: 208/220/230/240Vac

1000VA ~ 3000VA

Content

1. Safety Instructions	1
1.1 Installation.....	1
1.2 Operation.....	2
1.3. Maintenance, Servicing and Fault.....	2
1.4 Transport	3
1.5 Storage	3
2. Description of Commonly Used Notations	4
3. Introduction	5
3.1 Functions Description.....	5
3.2 Front Panel.....	6
3.3 Parameter Setting	8
3.4 UPS Working Mode	16
4. Connection and Operation	18
4.1 Unpacking and Inspection.....	18
4.2 Installation.....	18
4.3 Wiring.....	18
4.4 Output Wiring.....	19
4.5 Connect External Battery(Optional).....	21
4.6 Communication Cable (Optionl).....	22
4.7 Free Software Download – WinPower.....	24
4.8 Turn ON The UPS.....	25
4.9 Turn OFF The UPS.....	25
4.10 Enter Setting Mode.....	25

4.11 Battery Self-test.....	26
4.12 Buzzer Mute.....	26
5. Maintenance.....	27
5.1 Routine Maintain.....	27
5.1 Battery Maintain.....	27
6. Typical Trouble Shooting.....	28
7. Product Specification.....	30
7.1 Electrical Specification.....	30
7.2 Environment Specification.....	31
Appendix : Rear Panel of UPS.....	32

1. Safety Instructions

Please read the following content and safety instructions before installation or operation.

1.1 Installation

- Condensation may occur if the UPS system is moved directly from a cold to a warm environment. The UPS system must be absolutely dry before being installed. Please allow an acclimatization time of at least two hours.
- Do not install the UPS system near water or in damp environments.
- Do not install the UPS system where it would be exposed to direct sunlight or near heat.
- Do not connect appliances or items of equipment which would overload the UPS system (e.g. laser printers) to the UPS output terminals or sockets.
- Place cables in such a way that no one can step on or trip over them.
- Assure to connect with the earth reliably.
- Connect the UPS only to a socket outlet which is earthed shockproof type.
- The building wiring socket outlet (shockproof socket outlet) must be easily accessible to close to the UPS.
- With the installation of the equipment, the sum of the leakage current of the UPS and the connected load does not exceed 3.5mA.
- Do not block ventilation openings on the UPS's housing. Ensure the air vents on the front, side and rear of the UPS are not blocked. Recommended at least 25cm of space on each side.
- This UPS receives power from more than one source-disconnection of AC source and the DC source is required to de-energize this unit before servicing.

1.2 Operation

- For safety consideration, do not disconnect the mains cable on the UPS or the building wiring socket (grounded shockproof socket) during operation the grounding for the UPS and all loads connected will be disconnected.
- The UPS features its own, internal current source (batteries). You may be electric shocked when you touch the UPS output sockets or output terminal block even if the UPS is not connected to the building wiring socket.
- In order to fully disconnect the UPS, first press the OFF button to turn off the UPS, and then disconnect the mains lead.
- Ensure that no liquid or other external objects can enter the UPS.
- Do not remove the enclosure. This system is to be serviced by qualified service person only. There are NO USER SERVICEABLE PARTS inside the UPS.
- Remove the protective panel only after disconnecting the terminal connections.

1.3 Maintenance, Servicing and Fault

- The UPS operates with hazardous voltages. Repairs may be carried out only by qualified maintenance/service person.
- Caution - risk of electric shock. Even after the unit is disconnected from the mains power supply (building wiring socket), components inside the UPS are still connected to the battery which are potentially dangerous.
- Before carrying out any kind of service and/or maintenance, disconnect the batteries. Verify that no current is present and no hazardous voltage exists in the capacitor or BUS capacitor terminals.
- Batteries must be replaced only by qualified person.

Caution - risk of electric shock. The battery circuit is not isolated from the input voltage. Hazardous voltages may occur between the battery terminals and the ground. Verify that no voltage is present before servicing!

- Batteries have a high short-circuited current and pose a risk of shock. Take all precautionary measures specified below and any other measures necessary when working with batteries:
 - remove all jewellery, wristwatches, rings and other metal objects
 - use only tools with insulated grips and handles.
 - Wear rubber gloves and boots.
 - Do not lay tools or metal parts on top of batteries.
 - Disconnect the charging source prior to connecting or disconnecting battery terminals.

When changing batteries, replace with the same quantity and the same type of batteries.

- Do not attempt to dispose of batteries by burning them. It could cause explosion.
- Do not open or destroy batteries. Effluent electrolyte can cause injury to the skin and eyes, it may be toxic.
- Please replace the fuse only by a fuse of the same type and of the same amperage on order to avoid fire hazards.
- Do not dismantle the UPS, except the qualified maintenance person.

1.4 Transport

- Please transport the UPS only in the original packaging (to protect against shock and impact).











1.5 Storage

- The UPS must be stockpiled in the room where it is ventilated and dry.

NOTE: This is a category C2 UPS product. In a residential environment, this product may cause radio interference, in which case the user may be required to take additional measures.

2. Description of Commonly Used Notations

Some or all of the following notations may be used in this manual and may appear in your application process. Therefore, all users should be familiar with them and understand their explanations.

Nation and Explanation			
Nation	Explanation	Nation	Explanation
	Alert you to pay special attention		Protective ground
	Caution of high voltage		Overload indication
	ON/OFF		Bypass
	Alternating current source (AC)		Inverter
	Direct current source (DC)		Do not dispose with ordinary trash
	Battery		

3. Introduction

3.1 Functions Description

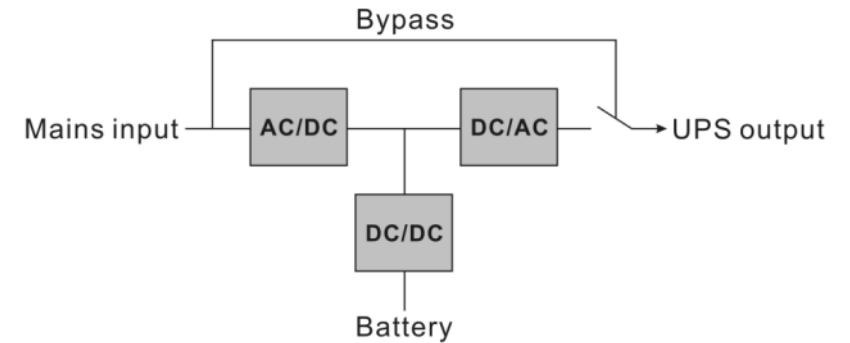

This product is a true online double-conversion UPS (Uninterruptible Power Supply). It provides perfect protection for critical load such as computer system. It can eliminate almost all mains power disturbances. The input AC current can be corrected to a wave following the mains voltage, so it is a high power factor system. Through the PWM control technology, the output voltage can be a pure & stable sine wave AC voltage.

When the mains input become abnormal, the controller will stop the AC/DC and start the DC/DC section immediately to make sure the DC/AC (inverter) section can continue to work. After the mains input come back to normal range, the DC/DC will be stopped and the AC/DC works again. So the load is always power-supplied through inverter without any interrupt if the UPS is turned on.

The UPS also provides an internal bypass way to make the load can be powered by mains input directly when the UPS is off or failed.

The UPS have an internal charger for batteries, the charger will charge the batteries when the AC main is in a reasonable range on "bypass mode" or "line mode".

3.2 Front Panel

◆ LCD Display:

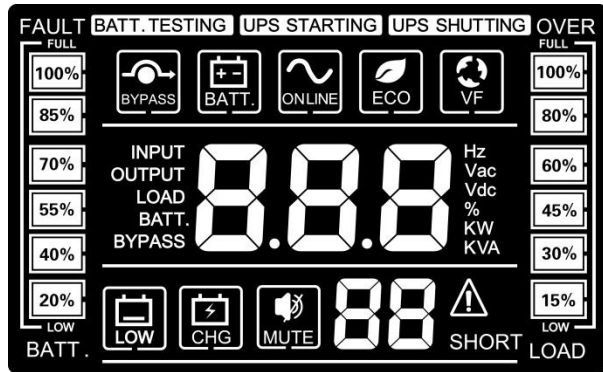

◆ Button Information:

Switch	Function
ON/OFF-Button	By pressing this button, to turn on or turn off the UPS system.
TEST/UP-Button	By pressing this button, to select the information of LCD display, and activate the battery self-test function.
MUTE/DOWN-Button	By pressing this button, to select the information of LCD display, and mute/recover the buzzer alarm function.
ENTER-Button	By pressing this button, to enter setting mode and confirm the change of setting.

◆ LCD Display Information:

Input information		Output information	
INPUT	It indicates the AC input.	OUTPUT	It indicates the AC output.
	It indicates the input voltage, frequency, battery voltage.		It indicates the output voltage, output frequency, loading percentage.

◆ LCD Display Information:

Battery information		Fault information	
	Divides into 5 battery levels which shows 0-20%, 21-40%, 41-55%, 56-70% 71-85% and 86-100% on display in Battery mode, and indicates charging status in Line mode. FAULT: Indicate the UPS is faulty.		Indicates the warning or fault status occurs to the UPS. Warning: flashing with warning code displayed. Fault: lighting with fault code displayed.
	LOW: Indicate low voltage of battery.		
Battery charge information		Silent mode	
	Indicates charging status in Line mode.		Indicates the UPS has been enabled in silent mode.
Mode Operation information			
	In On line mode.		In battery mode, AC Mains is abnormal, Battery supply inverter output.
	In ECO mode.		In bypass mode, the load is not protected by the UPS.
	In CVCF(constant voltage, constant frequency) mode.		Battery Testing Ongoing.
	UPS is turning On		UPS is turning Off

Load information	
<p>The scale shows percentages: 15%, 30%, 45%, 60%, 80%, 100%. Labels include SHORT, LOW, and OVER.</p>	<p>Indicates the load level which is divided into 0-15%, 16-30%, 31-45%, 46-60%, 61-80% and 81-100% on display.</p> <p>SHORT: Indicates with a small load.</p> <p>OVER: Indicates overload.</p>

3.3 Parameter Setting

In bypass/standby mode, press the ENTER button for 2 seconds, the UPS will enter Parameter Setting mode, and the LCD displays as follow.

Display	Description
	<p>Parameter name indicates the parameter object to be set.</p> <p>Setpoint is the target value:</p> <ol style="list-style-type: none"> 1. Use UP or DOWN button to choose the object and value to set. 2. Use ENTER button to activate the value. 3. Use ON/OFF button to exit setting mode.

The parameter will be saved only when the UPS is completely shut down under the battery mode. Besides, batteries must be well-connected to complete parameter setting. After the parameter setting is finished, cut off the mains input and wait for about 1 minute until the UPS automatically shut down and the settings will be saved. The new parameter value will be available when the next time UPS is turned on.

■ Output Voltage

Display	Example
<p>Parameter: Output Voltage</p> <p>■ <u>UPS model in LV system</u> (100/110/120/125Vac):</p> <p>“100” displayed on LCD indicates that output voltage will be 100Vac.</p> <p>“110” displayed on LCD indicates that output voltage will be 110Vac.</p> <p>“120” displayed on LCD indicates that output voltage will be 120Vac.</p> <p>“125” displayed on LCD indicates that output voltage will be 125Vac</p>	<p>Use UP or DOWN button to find the demand value, then press ENTER button to activate the value. Once the value is activated, there is “Vac” icon shown behind the value.</p> <p>■ <u>UPS model in LV system</u> (100/110/120/125Vac):</p> <p>Below is the display example when the output voltage changes to 120Vac.</p> <p>■ <u>UPS model in HV system</u> (208/220/230/240Vac):</p> <p>Below is the display example when the output voltage changes to 230Vac.</p>

■ UPS model in HV system

(208/220/230/240Vac):

“208” displayed on LCD indicates that output voltage will be 208Vac.



“220” displayed on LCD indicates that output voltage will be 220Vac.



“230” displayed on LCD indicates that output voltage will be 230Vac.



“240” displayed on LCD indicates that output voltage will be 240Vac



■ **Output Frequency**

Display	Example
Parameter: Output Frequency 	Use UP or DOWN button to find demand value, then press ENTER button to activate the value. Once the value is activated, there is “Hz” icon

000: Indicate Auto-detect, UPS will automatically detect the mains frequency to determine the value of output frequency when UPS is powered by mains supply.



050: 50Hz rated frequency (Fixed)



060: 60Hz rated frequency (Fixed)



shown on display.

Below is the display example when the output frequency is with the status of auto-detect.



■ **Auto Turn ON Setting**

Display	Example
Parameter: Auto Turn ON Setting 	Use UP or DOWN button to find demand value, then press ENTER button to activate the value. Once the value is activated, there is “OUTPUT” icon shown on display.
ON: ENABLE auto turn on function. When the UPS is powered by AC mains, the UPS will automatically turn on and switch to Line mode.	Below is the display example when auto turn on function is ENABLED status.

<p>OFF : DISABLE auto turn on function. Except for being manually operated, the UPS will stay in standby mode /bypass mode.</p>	

■ Emergency Power OFF (EPO) Setting (Optional)

Display	Example
Parameter: Emergency Power OFF (EPO) switch response setting	
	Use UP or DOWN button to find demand value, then press ENTER button to activate the value. Once the value is activated, there is "OUTPUT" icon shown on display.
001: ENABLE EPO	
	Below is the display example when EPO function is DISABLED.
000: DISABLE EPO	
0n1: EPO activated for EPO switch open	

<p>0n0: EPO activated for EPO switch close</p>	

■ Remote ON/OFF (ROO) Setting(Optional)

Display	Example
Parameter: Remote ON/OFF (ROO) switch response setting.	
	Use UP or DOWN button to find demand value, then press ENTER button to activate the value. Once the value is activated, there is "OUTPUT" icon shown on display.
001: ENABLE ROO	
	Below is the display example when ROO function is DISABLED.
000: DISABLE ROO	
0n1: ROO activated (Turn on UPS for ROO switch open. And switch close will turn the UPS OFF.	

On0: ROO activated (Turn on UPS) for ROO switch close. And switch open will turn the UPS OFF.



The default of EPO and ROO function is OFF (EPO=000 ROO=000).

When turn on EPO function (EPO=001), the default activating logic level is NO (ON0), i.e. the switch open will active EPO.

When turn on ROO function (ROO=001), the default activating logic level is NO (ON0), i.e. the switch open will turn the UPS off, and the switch close will turn the UPS on.

Please note that the UPS can turn on/off by ROO switch ON/OFF back and forth only when AC mains supply. Once the UPS is turned off by ROO switch in battery mode, the product will not be controlled by ROO switch and shut down completely until AC mains supply normally.

The UPS will come with the additional short circuit jumper wire to ensure the product can work normally when EPO/ROO function is on. The UPS will work normally until the jumper wire is removed/opened intentionally.

■ Bypass Setting

Display	Example
Parameter: Bypass setting. 	Use UP or DOWN button to find demand value, then press ENTER button to substitute into the value, once the value is substituted, there is

If DISABLE, the bypass output will turn OFF when UPS is not on inverter output mode (Line mode/Battery mode).

OFF: DISABLE bypass mode



If ENABLE, the bypass output will turn ON when UPS is not in inverter output mode (Line mode/Battery mode). When the mains input is normal, please make sure the UPS should be turn ON if the load needs to be protected by the UPS.

ON: ENABLE bypass mode.



“OUTPUT” icon shown under the value.

Below is the display example when bypass setting is ENABLED.



■ ECO Mode Setting

Display	Example
Parameter: ECO mode setting 	Use UP or DOWN button to find demand value, then press ENTER button to substitute into the value, once the value is substituted, there is “OUTPUT” icon shown under the value. Below is the display example when ECO

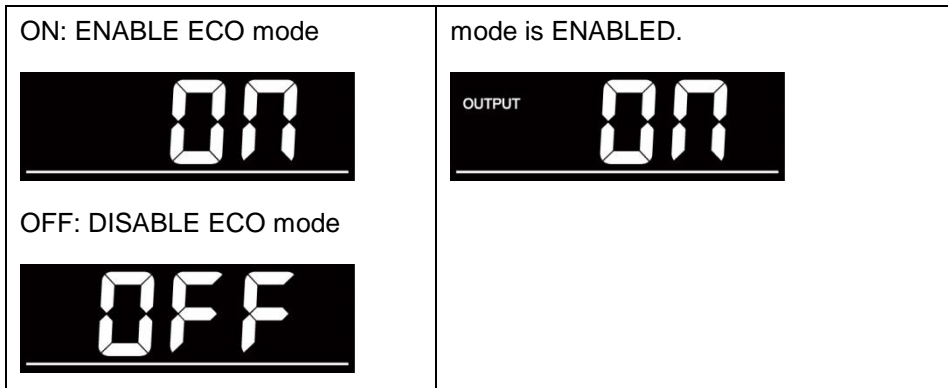

3.4 UPS Working Mode

3.4.1 Normal mode

If the mains supply is normal, UPS will work in Normal mode (Line mode). It will connect and filter the mains input to ensure AC output can be clean and stable. The indicators will show the operating mode.

If the loading level of rated capacity is over 100%, the buzzer will beep to remind you that the UPS is overloaded. You must reduce unnecessary load until the loading level of UPS is less than 100%.

If the battery indicator blinks cyclically, it shows that the UPS may disconnect from battery or the battery condition is abnormal. Please check the battery connection and battery condition to prevent the UPS output has unexpectedly interruption when the mains went out.

3.4.2 Battery mode

When the mains electricity is abnormal, such as the blackout or the fluctuation in voltage, frequency and waveform, UPS will switch to battery mode automatically. The energy source will change to be offered by the battery in order to keep the output stability of AC power supply.

In Battery mode, UPS will beep once every 4 seconds; the user can mute the buzzer beep by pressing the MUTE button.

If the battery capacity is very low, the UPS will beep once every 1 second. It reminds user to remove the loads as soon as possible.

Backup function can be tested through battery self-test via TEST button.

3.4.3 Bypass mode

When UPS starts up or its converters have abnormal situation and cannot work properly, the UPS will enter in Bypass mode.

Please note that the connected load will take over the mains electricity directly through the Bypass without protection when Bypass mode is on. And the backup function of UPS is also not available in Bypass mode.

4. Connection and Operation

The system may be installed and wired only by qualified electricians in accordance with applicable safety regulations!

When installing the electrical wiring, please note the nominal amperage of incoming feeder.

4.1 Unpacking and Inspection:

Inspect the appearance of the UPS to see if there is any damage during transportation. If there is any damage or lack of some parts, please do not turn on the UPS and notify the distributor immediately. Please keep the packaging in a safe place for future use.

Note: To avoid any safety issue, please ensure that the incoming feeder (mains) has complete isolation while whole process of installing.

4.2 Installation:

Since the weight of UPS is heavy, it needs to have UPS in place where is cool and with good ventilation, less humidity and less dust to make sure the UPS can work safely and stably. Always keep the space about 200 mm behind the UPS rear panel. Check that the indications on label that pasted on the UPS meets to the AC-power source and the true electrical consumption of the total load.

4.3 Wiring:

NOTE: Do not supply the electricity to the UPS before complete installation. Do not change the UPS settings at discretion, or it may damage your equipment and cause warranty void.

UPS usually comes with input cable plug. Please plug the input cable to suitable mains socket.

If 3KVA model comes with permanent input terminal block, please refer to the below table and choose the suitable size of wiring cable and cable protection pipe. Remember that the terminal block cover should be properly installed. Please note the voltage and current rating of the product and refer to the below table for corresponding input wiring.

■ UPS model in LV system (100/110/120/125Vac):

Model	Nominal Input Voltage	Rated Input Current	Input Cable AWG/Cross-section Area	Terminal Block Tightening Torque
1KVA	100/110/ 120/125Vac	10/10/9.6/9.3A	Standard cable with plug	N/A
2KVA		16/16/16/16A		
3KVA		26.4/28.2/25.8/ 24.8A	8AWG for L/N, 10AWG for earthing	0.5Nm (4.4 Lb In)

■ UPS model in HV system (208/220/230/240Vac):

Model	Nominal Input Voltage	Rated Input Current	Input Cable AWG/Cross-section Area	Terminal Block Tightening Torque
1KVA	208/220/ 230/240Vac	5.6/5.5/5.2/5.1A	Standard cable with plug	N/A
2KVA		10/10/10/9.8A		
3KVA		16/16/15.5/14.4A		

Even the product has embedded the internal overcurrent protection breaker, the external switchable circuit breaker should be installed at upstream of UPS for safe installation and product maintenance.

4.4 Output Wiring:

The input of equipment which needs to be protected by UPS should connect with the output of UPS. If the output of UPS has available terminal block, please refer to the below table.

■ UPS model in LV system (100/110/120/125Vac):

Rating Capacity	Output Terminal Block & Wiring Cable AWG/Cross-section Area	Terminal Block Tightening Torque
1KVA	NA	NA
2KVA		
3KVA	10AWG for output L/N 10AWG for bonding Use 75°C copper wire	0.5Nm (4.4 Lb In)

■ UPS model in HV system (208/220/230/240Vac):

Rating Capacity	Output Terminal Block & Wiring Cable AWG/Cross-section Area	Terminal Block Tightening Torque
1KVA	NA	NA
2KVA		
3KVA	14AWG 1.5mm ²	0.5Nm (4.4 Lb In)

Please find rated output capacity of product. Make sure to avoid overload and then use wire with sufficient current rating, please refer to the below table.

■ UPS model in LV system (100/110/120/125Vac):

Model	Nominal Output Voltage	Rated Output Current	Wire for Terminal	Tightening Torque
1KVA	100/110/ 120/125Vac	9.0/9.1/8.4/8.1A	N/A	N/A
2KVA		18.0/18.1/16.6/ 16.0A		
3KVA		24.4/24.5/25/24A	>12AWG/4mm ² Use 75°C copper wire	0.5Nm (4.4 Lb In)

■ UPS model in HV system (208/220/230/240Vac):

Model	Nominal Output Voltage	Rated Output Current	Wire for Terminal	Tightening Torque
1KVA	208/220/ 230/240Vac	4.3/4.5/4.3/4.2A	N/A	N/A
2KVA		8.6/9.1/8.7/8.3A		
3KVA		13/13.6/13/12.5A	14AWG 1.5mm ²	0.5Nm (4.4 Lb In)

Procedure for output wiring:

1. Plug the AC input cord of your loading equipment in the outlet of the UPS.
2. If the quantity of the loading equipment is more than the available outlet of UPS, please use the extension cord to connect with UPS outlet or UPS output terminal block. And be careful the total current consumption of loading equipment must not exceed rated current of UPS.
3. The output terminal is protected by a cover. Please remove the cover from the terminal, then use appropriate connecting terminal and prepare the wire.
4. Fix the appropriate wire to the terminal block, then check the silkscreen marking for polarity when wiring.

- If UPS unit has input and output terminal, refer to below:

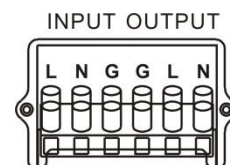

Input L / Output L : Black color wiring.
Input N / Output N : White color wiring.
Input G / Output G : Green color wiring.

- If UPS unit has output terminal only, refer to below::

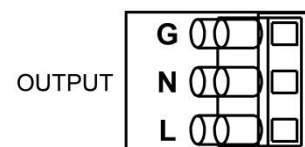

Output L : Black color wiring.
Output N : White color wiring.
Output G : Green color wiring.

4.5 Connect External Battery (Optional):

Connection of external battery is ABSOLUTELY CRITICAL. It may cause serious injure of electric shock, fire or product damage by any mistake of connection.

Below are the steps must be strictly followed.

Model	Nominal Battery Voltage	Rated Battery Current	Recommended Wiring cable
1KVA	24VDC	45A	>10AWG/6mm ²
2KVA	48VDC	45A	>10AWG/6mm ²
3KVA	72VDC	45A	>10AWG/6mm ²

1. The external battery bank must conform to the rated voltage of battery for UPS. The rated voltage of battery can be found by the label pasted on the UPS.
2. External battery bank has an extending port, which is used to extend the capacity of external battery. Please plug battery cable to the extending port of adjacent model, and connect the battery cable of the last module with the UPS battery connector which is on the rear panel.
3. Please use the battery bank with correct voltage. The correct rated voltage information can be checked on the label pasted on the product.
4. Choose wire with sufficient current rated, prepared well the terminal.
5. CHECK THE POLARITY of battery bank, fix wires of correct polarity to the battery bank with proper color and clear label to distinguish the polarity.
6. Plug or fix firmly the other end of the cable to UPS.
7. Check the polarity of the wiring, and then connect the connection firmly.
8. After external battery installation is finished, you may turn on the UPS on battery mode.

4.6 Communication Cable (Optional):

1. RS-232: Connect UPS computer Interface (RS232) and monitor equipment through communication cable.
2. Intelligent Card Slot is used to install NMC(Network Management Card), AS400 Card , CMC(Centralized Monitoring Card), to implement Network Monitoring, RS485 based ModBUS protocol monitoring.
3. The USB port is a serial port emulator will allow you to create virtual RS232 ports linked via a USB Port, the UPS could be manage through the same management software. However, it does not support HID USB Power part operating mode.

4. The Product also provides optional Modbus Port, Relay Dry contact card, refer to optional port user manual for application.
5. EPO/ROO port is a dry contact input port, incorporating with external switches, used to implement Emergency Power Off (EPO) and Remote On/Off(ROO) functions, find below the wiring diagram of EPO & ROO switches, 4 poles from left to right.

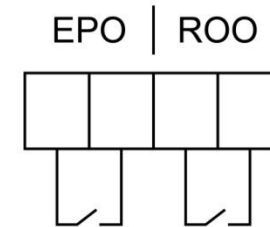

4.7 Free Software Download – WinPower

WinPower is a brand new UPS monitoring software, which provides user-friendly interface to monitor and control your UPS. This unique software provides safely auto shutdown for multi-computer systems while power failure. With this software, users can monitor and control any UPS on the same LAN no matter how far from the UPS.

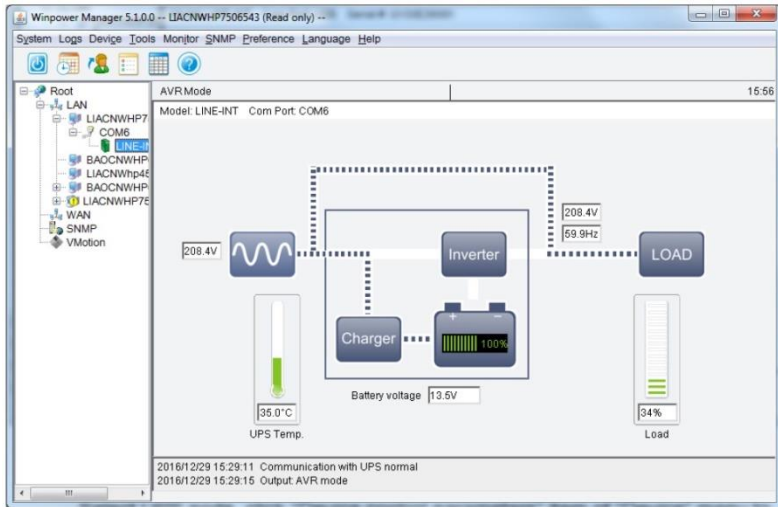

Installation Procedure:

1. Go to the website:

<http://www.ups-software-download.com/content/ups-download-software/download.html>

2. Choose the operation system you need and follow the instruction described on the website to download the software.

3. When downloading all required files from the internet, enter the serial No: **511C1-01220-0100-478DF2A** to install the software.

When your computer restarts, the WinPower software will appear as a green plug icon located in the system tray, near the clock.

4.8 Turn ON The UPS:

1) With mains power connecting:

Connect the mains input to the UPS, press and hold the ON button for more than 3 seconds until the buzzer beeps. Then UPS begins to conduct self-test, seconds later, utility power icon and the Inverter icon shown and the UPS begins to supply output and operate under the Normal mode. If the utility power is abnormal, then UPS will work under the Battery mode.

2) Without mains power connecting:

Press ON button for more than 3 seconds and the UPS will response with a buzzer beep. During the turn on process, the UPS will conduct same operation as it is connected to utility power, however, the utility power icon will not be shown, instead the battery icon shown.

4.9 Turn OFF The UPS:

1) In Normal Mode:

Press OFF button for more than 3 seconds, then UPS will turn off. If bypass mode is enable, the bypass indicator will be turned on to indicate that UPS is working on bypass mode. In order to cut off the output of the UPS, simply cut off the utility power. Finally, no any display is shown on the front panel and no output power is available from the UPS outlets.

2) In Battery Mode:

Press OFF button for more than 3 seconds, then UPS will turn off. The UPS cut off output supply, and UPS will completely turn off after approximately 1 minute.

4.10 Enter Setting Mode:

When UPS works on Bypass or Standby Mode, press ENTER button for 5 seconds, the UPS will enter setting mode, including setting of output voltage, frequency, bypass enable/disable, ECO mode enable/disable, EPO function (optional) ON/OFF.

Use UP button and DOWN button to change the setting and short press the ENTER button to confirm the change.

To complete the changes of value setting, turn off the mains power supply, wait the UPS turn off under battery mode until LCD display is totally off, then turn on the UPS again to activate the setting change.

4.11 Battery Self-test:

In Normal mode, press the TEST button for more than 4 seconds until the buzzer beeps. The UPS will switch to battery test mode to check the status of the battery. The UPS will exit the battery test mode if the battery abnormal and present alarm with the battery icon flashing. If test mode ends up with normal, the UPS will switch to normal mode automatically.

4.12 Buzzer Mute:

When UPS is on Battery or Bypass mode, UPS will beep with warning tone. Buzzer will beep 4 seconds one tone on battery mode, 2 minutes one tone on Bypass mode. You can disable or enable the buzzer tone manually.

In the Battery and Bypass mode, press MUTE button for about 4 seconds until you hear a buzzer beep, then the buzzer alarm is muted. Press the button for 4 seconds again to recover the buzzer alarm function.

The buzzer mute is valid only in battery mode, and buzzer mute will be invalid if any UPS alarm happened.

5. Maintenance

5.1 Routine Maintain

To make sure UPS work normal, appropriate maintenance should be scheduled periodically, below items should be checked.

- Check UPS operation status

If the utility power is normal, UPS should work on line mode or battery mode.

And there will be no warning or fault indication shown.

- Check UPS operation mode transfer action

You may cut off the AC mains to simulate the utility power interruption, UPS should transfer to battery mode. Then connect the AC mains again, UPS will switch back to line mode.

- Check UPS panel

Check UPS panel display if it is consistent with UPS operation mode.

5.2 Battery Maintain

Typical life span of a lead-acid battery is 300 cycle or 2~3 years in an environment of 15-25°C ambient temperature.

Battery is a very important part in the UPS system. The life of battery can be affected by the environment temperature and the cycle of usage times. High temperature or deep discharge will decrease the battery life.

To proceed battery test progress can find out the most problems of the batteries.

For external battery bank (optional), voltage value of each battery unit can be an indicator for the battery health status.

Leaving battery uncharged, voltage of bad battery unit will drop quickly or significantly stray from the rest battery unit in the same battery bank.

Battery checking is necessary to test battery by using battery diagnostic instrument, it can measure battery impedance.

If UPS is not used, it is suggested to charge the battery once every 6 months.

Normally, the battery should be discharged once every 4 to 6 months.

The battery replacement should be done by qualified technician, please get the advice from local distributor

6. Typical Trouble Shooting

If the UPS system does not operate correctly, first check the operating information on the LCD display. Please attempt to solve the problem using the table below. If the problem still persists, consult your dealer.

Fault Code	Description	Possible Problems and Solutions
01	UPS is failed to start up	Battery low voltage.
		UPS Internal failure. Call for service.
02	Internal DC BUS over-voltage protection	Half-wave rectifier load (hair dryer, half-wave solenoid valve, energy re-generated type load, motor, huge transformer, capacitor with residue charge) Remove this kind of load and turn on the UPS again.
		AC power over voltage. Turn on the UPS again.
		UPS Internal failure. Call for service.
03	Internal DC BUS under-voltage protection	Battery low voltage. Or overload.
		UPS Internal failure. Call for service.
10	UPS Output short-Circuit	Remove short-circuit equipment from UPS.
22	UPS Over Load	Reduce loading capacity below UPS rating.
23	UPS Over Temperature	Make sure UPS should work in ambient of -10-45°C, if the ambient temperature can't meet this spec., try to reduce loading.
		Check ventilation of the UPS; make sure the ventilation is not blocked.
		UPS Internal failure. Contact distributor for service.
29	UPS Input rectifier protection	Low input voltage and overload.
		UPS Internal failure. Contact distributor for service.

Fault Code	Description	Possible Problems and Solutions
57	Battery UN-connected	Check battery input wiring, and the cut-off device of battery such as circuit breaker etc.
59	Charger Fail	UPS Internal failure. Call for service.
60	EPO activated (optional)	Reset the External EPO switch, if no EPO switch installed, turn off EPO function via the operating panel.
Battery icon flashing		Battery is not connected or battery low voltage.
		Charger failure. Call for service.
UPS is not working on Line mode even with normal AC power input		Make sure input circuit breaker is ON.
		Turn on the UPS by pressing ON/OFF button.
Battery backup time is not long enough as expected		Battery low voltage. Recharge the battery for enough charging time.
		Overload. Reduce some loadings.
		Battery is aged. Call for service.
UPS is not turned on after pressing ON/OFF button		Press ON/OFF button for more than 3 seconds until hear a beep sound, then UPS should be on turn-on progress.
		Battery low voltage or battery is not connected.
		UPS Internal failure. Call for service.

7. Product Specification

7.1 Electrical Specification

Model	1KVA	2KVA	3KVA
Nominal Power	1000VA/900W	2000VA/1800W	3000VA/2700W
AC Input			
Input System	Single Phase (L/N+PE)		
Nominal Voltage	LV system: 100/110/120/125Vac HV system: 208/220/230/240Vac		
Frequency	50/60Hz		
Voltage Range	LV system: 65 ~ 145 +/- 5VAC HV system: 90 ~ 275 +/- 5VAC		
Frequency Range	40~70Hz +/- 0.5Hz		
Input Power Factor	>0.99		
Bypass Voltage Range	LV system: 95 ~ 130Vac (75~145Vac Max.) HV system: 187 ~ 265Vac (120~275Vac Max.)		
AC Output			
Output System	Single Phase (L/N+PE)		
Output Voltage (Inverter Mode)	LV system: 100/110/120/125Vac HV system: 208/220/230/240Vac		
Waveform	Sine Wave		
Harmonic Distortion	THD < 2% (Linear Load)		
Frequency	50/60±4Hz (Sync mode) 50/60Hz±1% (Fix Frequency mode)		
Overload Capacity	105 ~ 125%≥ 60s, 126 ~ 150%≥30s The recover point is 70%		
Transfer Time	Battery <-> Line Mode: 0ms		
Efficiency			
Line Mode	88%	89%	90%
Battery Mode	85%	86%	87%

* LV system (100/110/120/125Vac): Derating to 90% for 100V output operating.

* HV system (208/220/230/240Vac): Derating to 90% for 208V output operating.

Model	1KVA	2KVA	3KVA
Battery			
Rated Battery Voltage	24VDC	48VDC	72VDC
Number of Internal Battery	2	4	6
Recharge Time (to 90%)	5 hours	5 hours	5 hours
Alarm Function			
AC/DC input under abnormal, overload condition and Inverter problems.			
Protection Function			
Protection for High-voltage/Low-voltage, overload, over temperature and short circuit.			
Noise			
<50dB			

7.2 Environment Specification

Model	1KVA	2KVA	3KVA
Ambient Temperature	0°C ~ +40°C		
Storage Temperature (With battery)	-15°C ~ +40°C		
Storage Temperature (Without battery)	-25°C ~ +55°C		
Altitude	< 1000m (The load with no derating)		
	1000m < Altitude ≤ 3000m (The load should derating 1 % for every up 100m)		
Relative Humidity	0 ~ 97%, no condensing		

Appendix: Rear Panel of UPS

Note 1: The socket and terminal configuration may change due to different countries or regions.
 Note 2: It is suggested that the UPS output cable is not more than 10M. The external communication cable, the equipment connection cable, or the temperature detection cable is not more than 3M. Otherwise it may need to take installation restrictions or additional measures to suppress interference.

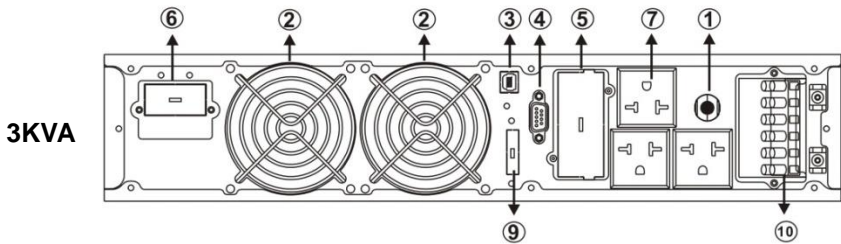
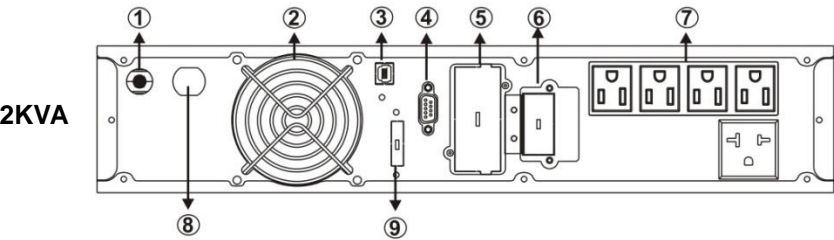
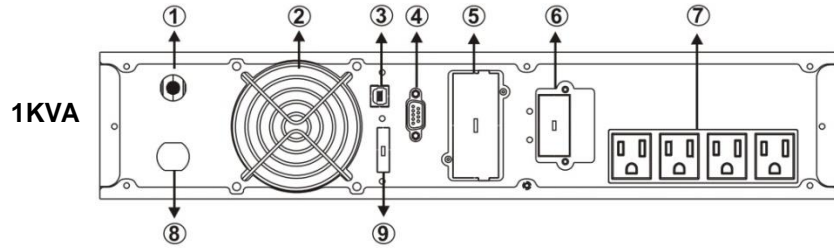

- ① Input Breaker
- ② Cooling Fan
- ③ Communication Port (Optional)
- ④ Communication Port (Optional)
- ⑤ Intelligent Slot(Optional)
- ⑥ External Battery Connector(Optional)
- ⑦ Output Socket
- ⑧ AC input
- ⑨ E.P.O. Port(Optional)
- ⑩ Terminal for Input/Output

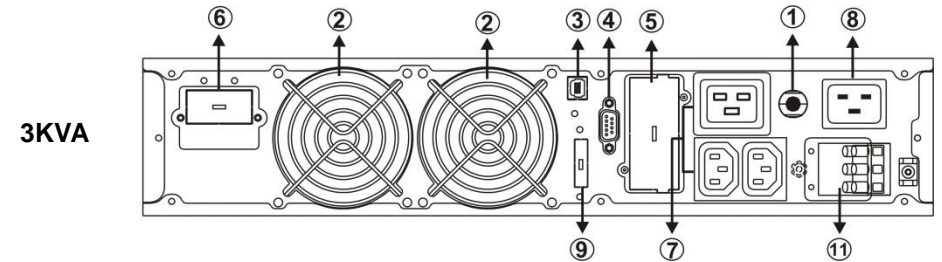
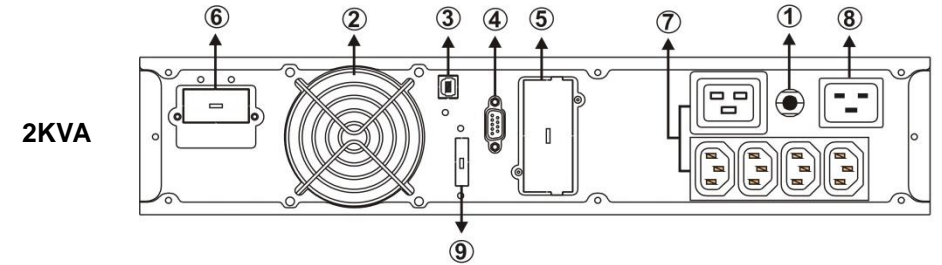
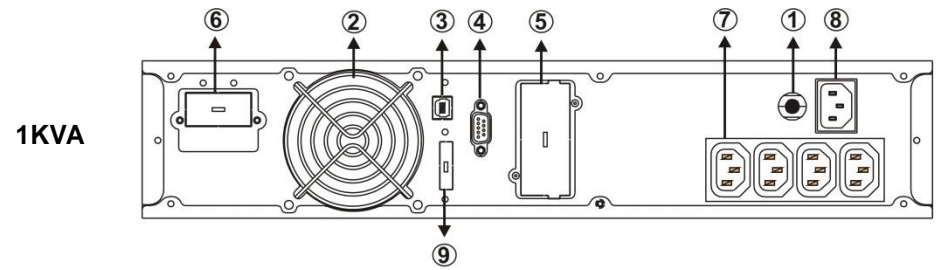

- ① Input Breaker
- ② Cooling Fan
- ③ Communication Port (Optional)
- ④ Communication Port (Optional)
- ⑤ Intelligent Slot(Optional)
- ⑥ External Battery Connector(Optional)
- ⑦ Output Socket
- ⑧ AC input
- ⑨ E.P.O. Port(Optional)
- ⑩ Terminal for Output

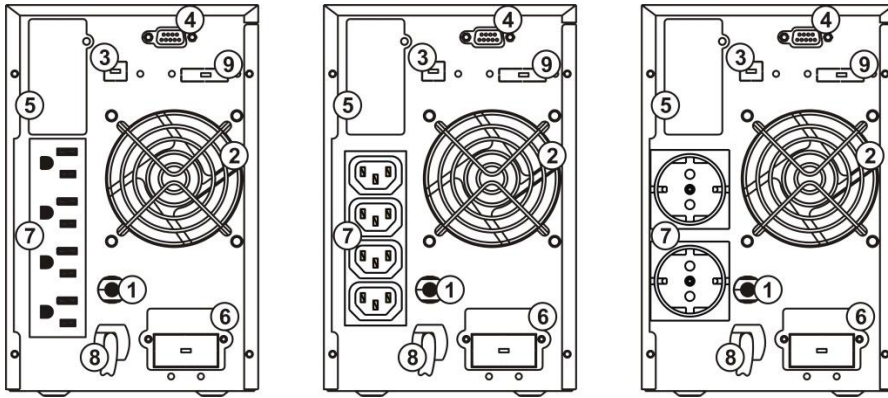

1KVA

- ① Input Breaker
- ② Cooling Fan
- ③ Communication Port (Optional)
- ④ Communication Port (Optional)
- ⑤ Intelligent Slot(Optional)
- ⑥ External Battery Connector(Optional)
- ⑦ Output Socket
- ⑧ AC input
- ⑨ E.P.O. Port(Optional)

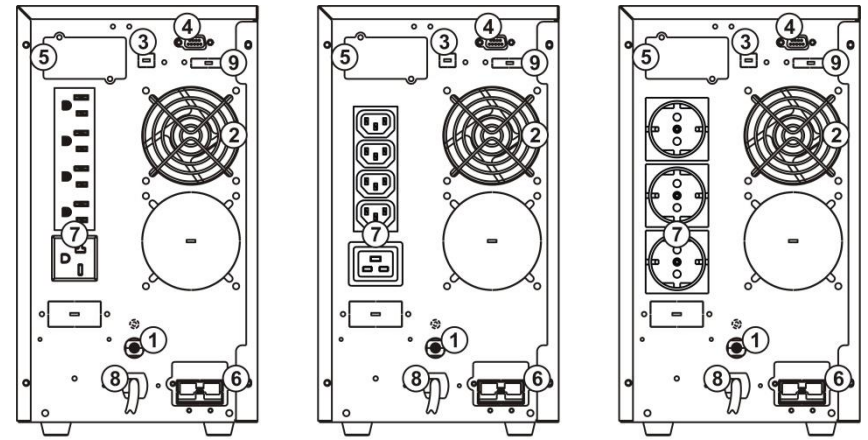

2KVA

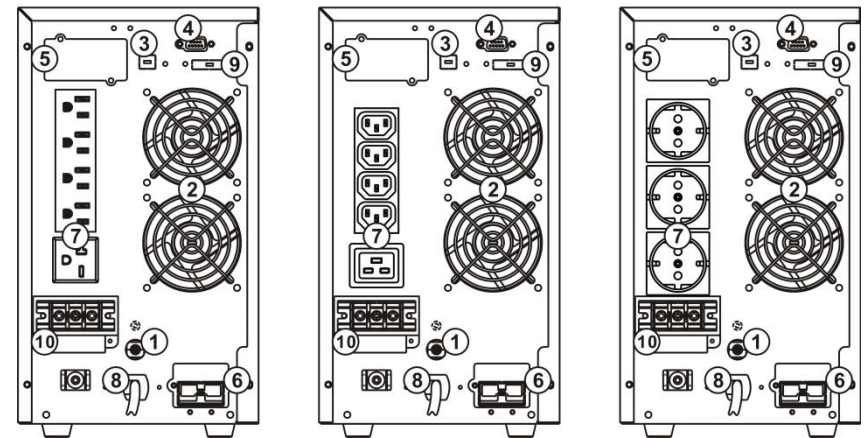

3KVA

- | | |
|---------------------------------|--|
| ① Input Breaker | ⑥ External Battery Connector(Optional) |
| ② Cooling Fan | ⑦ Output Socket |
| ③ Communication Port (Optional) | ⑧ AC input |
| ④ Communication Port (Optional) | ⑨ E.P.O. Port(Optional) |
| ⑤ Intelligent Slot(Optional) | ⑩ Terminal for Output |

